

GUIDE FOR SAFE DESIGN OF LIVESTOCK LOADING RAMPS AND FORCING YARDS



TABLE OF CONTENTS

OF LIVESTOCK LOADING RAMPS AND FORCING YARDS

TABLE OF CONTENTS

	PAGE	
1.0	Introduction	1
2.0	Scope	1
3.0	Disclaimer	1
4.0	Health and Safety Obligations	2
5.0	Animal Welfare Obligations	2
6.0	Identifying the Hazards	2
7.0	Assessing and Controlling Risks	3
8.0	Critical Control Points for Livestock Ramps and Forcing Yards	3
9.0	General Design Principles	5
10.0	Suggested Controls to Manage Specific Risks	6
10.1	Critical Control Point 1: Interface between truck and loading ramp	6
10.2	Critical Control Point 2: Exit / entry gate at top of ramp	9
10.3	Critical Control Point 3: Loading / unloading ramp parameters	10
10.4	Critical Control Point 4: Gaining access	13
10.5	Critical Control Point 5: Interface in forcing pen	16
10.6	Critical Control Point 6: Gates striking operator	17
11.0	Suggested Ramp Designs	18
11.1	Single deck and multi-deck ramps	18
11.2	Unloading ramps	18
11.3	Total number of ramps	18
11.4	Designs for cattle	19
11.5	Designs for sheep, pigs, lambs, goats and calves	19
11.6	Supporting infrastructure	19
Appendix A – Designs for Cattle		21
Appendix B – Designs for Sheep, Pigs, Lambs, Goats and Calves		28
Appendix C – Truck Loading Platform		33
Appendix D – Glossary of Terms		34
Appendix E – Key Contacts		35
Appendix F – Safety Authorities		37
Appendix G – Reference Material		38
Appendix H – Acknowledgements		39

1.0 INTRODUCTION

This guide provides information on the safe design, construction and operation of livestock loading/unloading ramps and forcing yards. **The purpose of the guide is to promote safer workplaces for people in contact with livestock loading facilities and to improve animal welfare outcomes.**

The guide is a tool to assist in the assessment of existing facilities and aid in the design of proposed new facilities. It summarises the potential hazards of livestock loading ramps and forcing yards and practical examples of ways to control associated risks for different types of facilities. General principles are identified as well as a series of model ramp designs (ranging from low-cost basic designs for farms to more advanced commercial designs) that adhere to these guidelines.

Legislation requires that safety risks be controlled as far as is reasonably practicable. Australian Animal Welfare Standards require livestock handling facilities be constructed, maintained and operated in a way that minimises risks to the welfare of livestock. The guide does not replace any statutory or accreditation requirements that may apply. Examples of other requirements that may apply are at **Appendix G**.

2.0 SCOPE

This guide deals with the movement of livestock and the facilities used from the time livestock are drafted into forcing pens, traverse a loading ramp and enter a transport vehicle (or vice versa). Other stages of the livestock supply chain are not included.

Examples of the types of facilities to which these guidelines may apply include farms, feedlots, spelling yards, saleyards, import/export terminals and abattoirs.

Examples of specific elements addressed include races, surfaces, side sheeting, supports, gates, latches, hinges, chains, ladders, steps, platforms, walkways, bridging, flaps, guards, winches, lighting, signage, vehicle access and management controls.

3.0 DISCLAIMER

This publication represents general advice only. Applicability to individual facilities must be assessed by users on a case by case basis. Some photos contained in this guide to illustrate a particular design principle may not be 100% compliant in other areas. If unsure, please contact your State or Territory Safety Authority (**Appendix F**).

To ensure you comply with your legal obligations you must refer to the appropriate legislation. This publication does not represent a comprehensive statement of the law as it applies to particular problems or to individuals or as a substitute for legal advice. You should seek independent legal advice if you need assistance on the application of the law to your situation.

The Australian Livestock and Rural Transporters Association (ALRTA) disclaims all warranties with regard to this information and in no event shall the ALRTA be liable for any direct or indirect consequential damages whatsoever arising from the use of this guide. The ALRTA reserves the right to alter, amend or rescind this publication at any time.

4.0 HEALTH AND SAFETY OBLIGATIONS

While specific legislation can differ across State and Territory jurisdictions, everyone in the workplace has a work health and safety duty. The main duties stipulated in the national Model Work Health and Safety Act are set out in **Table 1**.

WHO	DUTIES
Person conducting a business or undertaking	A person conducting a business or undertaking must ensure, so far as is reasonably practicable, that workers and other people (i.e. all persons who may be exposed to risks at a livestock loading location) are not exposed to health and safety and welfare risks arising from the business or undertaking.
Designers, manufacturers, suppliers and importers	Designers, manufacturers, suppliers and importers of plant or structures must ensure, so far as is reasonably practicable, the plant or structure is without risks to health and safety. For example, ensuring construction materials used for facilities are fit-for-purpose.
Officers	Officers, such as company directors, have a duty to exercise due diligence to ensure the business or undertaking complies with the Work Health and Safety Act and Regulations. This includes taking reasonable steps to ensure the business or undertaking has and uses appropriate resources and processes to eliminate or minimise risks at the workplace.
Workers and others	Workers and other people at the workplace must take reasonable care for their own health and safety, co-operate with reasonable policies, procedures and instructions and not adversely affect other people's health and safety.

Table 1: Main duties of the national Model Work Health and Safety Act

5.0 ANIMAL WELFARE OBLIGATIONS

All persons are subject to particular state and territory laws for the prevention of cruelty to animals including livestock. Additional specific duties also apply to all parties in the livestock supply chain under the Australian Animal Welfare Standards and Guidelines for the Land Transport of Livestock and the Australian Animal Welfare Standards and Guidelines for Saleyards and Depots (proposed).

Facilities that achieve excellence in animal welfare outcomes are safer for people too. Understanding animal behaviour is fundamental to designing facilities that promote a smooth flow and best practice (low stress) handling of livestock by competent livestock handlers.

6.0 IDENTIFYING THE HAZARDS

The first step in the risk management process is to identify all hazards. Hazard identification should be done as early as possible in the concept development and design phases. For proposed new infrastructure, this involves identifying issues, practices and situations that could potentially cause harm to people or animals throughout the livestock loading facility's lifecycle and the reasonably foreseeable hazards associated with each activity.

Hazards usually relate to the plant itself or how and where it is used. Hazards may be identified by conducting workplace inspections and reviewing work procedures in conjunction with this guide.

It is also beneficial to consult with workers, equipment users, manufacturers, importers, suppliers, plant and health and safety specialists and review relevant information, records and incident reports.

7.0 ASSESSING AND CONTROLLING RISKS

A risk assessment involves considering what could happen if a person or animal is exposed to a hazard and the likelihood of it happening. Risk controls must effectively eliminate the risk or, where that is not reasonably practicable, minimise the risk. Elimination is the most effective control measure and must always be considered before anything else.

This guide primarily aims to address hazards in the design phase. While sound livestock handling techniques are essential to reduce the risk from interacting with livestock, ensuring livestock loading facilities are appropriately designed to eliminate or minimise risk is the most effective method and can avoid costly changes after livestock loading facilities are operational.

The risk controls specified in these guidelines have been developed in consultation with industry participants across the animal supply chain. However, these controls are non-exhaustive and innovative approaches to controlling risk is encouraged where required.

8.0 CRITICAL CONTROL POINTS FOR LIVESTOCK RAMPS AND FORCING YARDS

A critical control point is the point in a process where failure to control known hazards can lead to serious harm to people, animals or equipment.

The livestock loading process is relatively common and well-understood. Industry experts agree that there are six critical control points as illustrated in the example cattle ramp and forcing yard at **Figure 1**.

Addressing these critical control points has the greatest impact in terms of reducing risks and meeting legislative obligations.

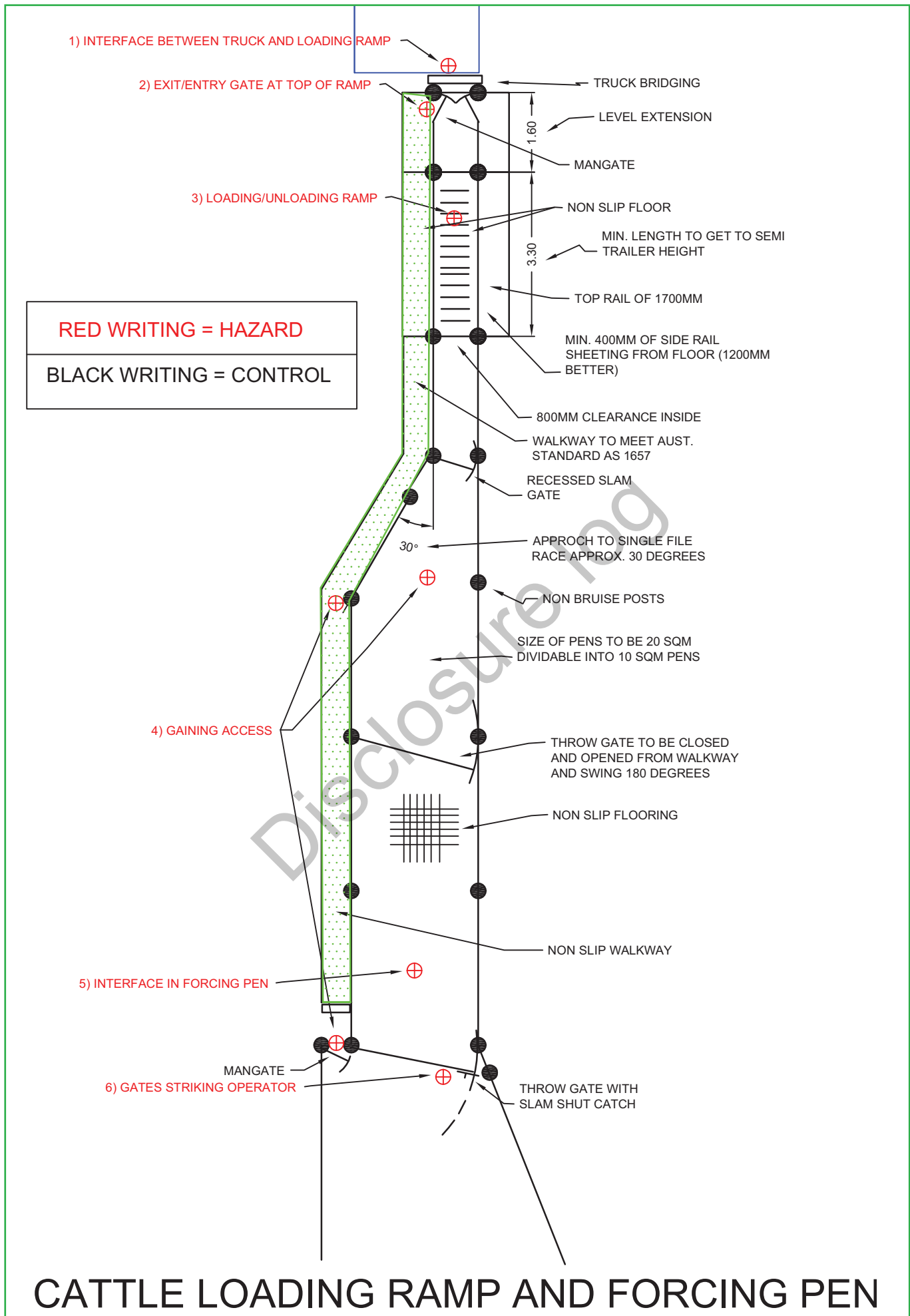

CATTLE LOADING RAMP AND FORCING PEN

FIGURE 1: CRITICAL CONTROL POINTS

9.0 GENERAL DESIGN PRINCIPLES

As the volume of livestock throughput and/or frequency of use increases, so do the potential risks and the need to have purpose built equipment that deals with these risks. Around Australia there are many different types of livestock loading facilities. The following scenarios typically apply:

- **Small farms:** low volume, infrequent usage.
- **Mid-farms / small commercial facilities:** medium volume, infrequent usage.
- **Large farms / medium commercial facilities:** medium volume, frequent usage.
- **Annual / special sales:** medium-high volume, infrequent usage.
- **Large commercial facilities:** high volume, high frequency.

Work health and safety laws recognise that what is 'reasonably practicable' for different facilities can vary depending upon factors such as frequency of use and exposure, type of stock being handled and environmental conditions. However, there are some general design principles that should be applied to all livestock loading facilities regardless of their size. These include:

Consider the primary aim:

- Separation of people and animals;
- Facilities should minimise safety and welfare risks and promote smooth 'flow' of livestock;

Consider the intended use:

- Ramps should be constructed appropriate to the species of stock and vehicles used;
- Ramps should be aligned north-south to avoid loading into the sun;
- Noise and visual distractions should be minimised;
- If the facility will be used at night, adequate overhead lighting should be provided capable of evenly illuminating pens, loading areas and vehicles to encourage safe animal movement;
- Ramps should be built to enable single operator use and ease of operation (**Note:** *It is advisable that ramps are not operated by a single person. However, where appropriate the ramp design should take into account that this is sometimes unavoidable*);

Get the design right:

- Facility operators should consult with facility users to assist in the initial design phase;
- Hazards should be addressed through good design in preference to management controls;
- Use non-slip (easy to clean) and non-bruising materials throughout;
- Engineer's information and statutory requirements should be referenced when designing new ramps or replacing bolts, cabling and hardware to maintain a safe working load limit;

Maintain safety standards:

- Facility operators should regularly consult with facility users to assist in the early identification of emerging safety risks;
- Facilities should be clean and in a good state of repair;
- Rated capacity should be displayed on the ramp and the working load limit displayed on any winch / hoist.
- Winches must comply with AS 1418.2 1997 and friction clutches are recommended;
- Persons using the facility should be appropriately trained according to their role;
- Signage should display emergency contact details for the facility operator;
- Facility users should report all faults or safety issues to management; and
- Review relevant hazards, risks and controls periodically and after an incident or near miss.

10.0 SUGGESTED CONTROLS TO MANAGE SPECIFIC RISKS

10.1 Critical Control Point 1: Interface between truck and loading ramp

#	HAZARD	RISKS	CONTROLS
1.	Poor vehicle access to loading point.	<ul style="list-style-type: none"> • Damage to vehicle or ramp. • Inefficient loading practices causing stress to people and animals. • Crash risk to vehicles on public roads. 	<ul style="list-style-type: none"> • Access should accommodate appropriate transport vehicles that frequent the site. • Ideally, access should at least provide for a b-double and larger vehicles such as road trains in areas where the road network allows. • Vehicular approach to the ramp should have a slight fall backwards to enable vehicles to be rolled into position gently. A line should be painted, or reflective material fitted, on the road surface to assist this approach. • Side loading vehicles should be able to approach a ramp on a level surface. • Ideally, vehicles should not be required to commence reversing on a public roadway (always check local laws). • Use of loading facilities should not block vehicle traffic flow either within the facility or on a public roadway. • Entry and exit points for vehicles should minimise traffic hazards. • Develop a consistent traffic flow plan (e.g. clock-wise only). • Ensure traffic flow is free from dangerous obstructions such as power lines and trees.
2.	Crushing point between rear of truck/trailer and front of ramp.	<ul style="list-style-type: none"> • Severe injury or death due to entrapment or being struck by vehicle. 	<ul style="list-style-type: none"> • No go zone behind vehicle. • Reversing alarms on vehicles.
3.	Ramp not securely fixed to the ground.	<ul style="list-style-type: none"> • Ramp moving backwards or becoming unstable when vehicle backs into it. 	<ul style="list-style-type: none"> • Fixed ramps must have suitable foundations to prevent movement. Refer Figure 8 • Portable ramps must be securely fixed and have suitable anchoring devices to prevent movement while stock is being loaded or unloaded e.g. wheel chocks and appropriately secured to the end of the vehicle. Refer Figure 2



FIGURE 2

10.1 Critical Control Point 1: Interface between truck and loading ramp, continued

#	HAZARD	RISKS	CONTROLS
4.	Ramp not securely fixed or aligned with the vehicle.	<ul style="list-style-type: none"> • Damage to rear of stock crate. • Slip, trip, fall Injury to operator. • Injury to stock due to legs falling between gaps. • If gap too excessive provides possible escape point for stock. • Risk to public being struck by escaped animals. • Operator being struck while retrieving flap. 	<ul style="list-style-type: none"> • Secure structure. • Solid extensions should be used to cover any gaps between the loading ramp floor and the floor of the vehicle. • Suitable alignment for truck to ramp. • Ramp at suitable height for vehicle. • Refer Figure 3a & 3b • Ideally, there should be a self-aligning compressible interface with the vehicle – particularly if drivers find it difficult to pull up ‘squarely’. Refer Figure 4a & 4b • Buffer stops on front of ramp in good condition. Refer Figures 4a & 4b • Curved (ideally) fold down flaps made from non-slip material available to compensate for height variation. Refer Figure 5 • Flap retrieval mechanism has a chain attached to the ramp in a position where the operator does not need to bend down and can access it from inside the ramp. Refer Figure 5



FIGURE 3a



FIGURE 4a



FIGURE 3b

Note – Ramp not at suitable height.



FIGURE 4b



FIGURE 5

10.1 Critical Control Point 1: Interface between truck and loading ramp, continued

#	HAZARD	RISKS	CONTROLS
5.	Rough, slippery or steep access from ground level to facility creating slip, trip or fall issue.	<ul style="list-style-type: none">Laceration or fracture injury to operator.	<ul style="list-style-type: none">Provision of suitable access such as walkway or ladder with non-slip surface to comply with the Australian Standard – AS1657-2013, 'Fixed platforms, walkways, stairways and ladders - Design, construction and installation'. Refer Figure 6



FIGURE 6

10.2 Critical Control Point 2: Exit/entry gate at top of ramp

#	HAZARD	RISKS	CONTROLS
1.	No emergency exit / entry gate at top of ramp.	<ul style="list-style-type: none"> Inability of operator to exit quickly in an emergency to prevent being struck by an animal. 	<ul style="list-style-type: none"> Self-closing, inward-opening, non-latching gate at top of ramp for emergency access. The gate should be ideally 500mm wide to prevent stock escaping and open onto a flat area free of obstructions. Refer Figure 7 Gate gives safe access to ensure that crate back door pin has been installed to prevent stock falling from truck during transit. Consider installing a walkway adjacent to vehicle so there is no need to enter the vehicle. Refer Appendix C
2.	No sliding gate at top of ramp.	<ul style="list-style-type: none"> Being struck by stock coming back out of vehicle while retrieving fold-over flap and/or closing crate door. Striking head on sliding gate frame. 	<ul style="list-style-type: none"> Provision of sliding gate provides safe access to rear of vehicle to close the crate door and for retrieval of flap. Refer Figure 8 Gate should be a reasonable size, be at floor level to avoid a tripping hazard and at a suitable height to avoid hitting head. External walkway to be positioned on the left hand side of the ramp (looking up from the base of the ramp) if no slide gate fitted.



FIGURE 7

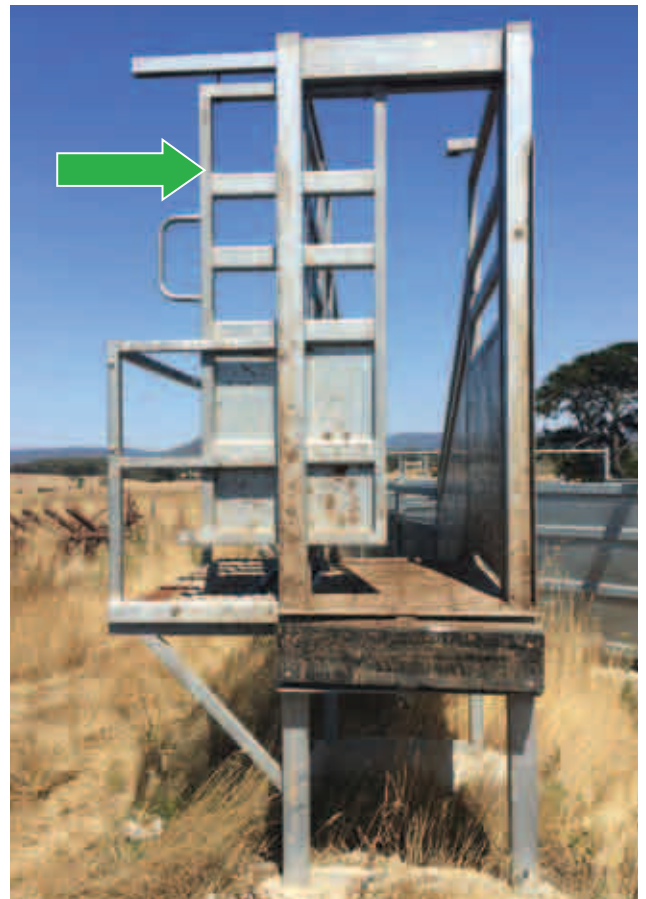

FIGURE 8

10.3 Critical Control Point 3: Loading/unloading ramps

#	HAZARD	RISKS	CONTROLS
1.	Loading/unloading into a multi-deck crate.	<ul style="list-style-type: none"> Slip, trip, fall Injury to livestock or operator. 	<ul style="list-style-type: none"> Decrease gradient via installing a multi-deck ramp – particularly in high use applications.
2.	Slippery surfaces or protruding objects.	<ul style="list-style-type: none"> Slip, trip, fall or impact Injury to livestock or operator. 	<ul style="list-style-type: none"> Ramps should be constructed with non-slip flooring (which is easy to clean) and non-bruise material. Refer Figures 9a & 9b Remove any sharp or protruding objects. Refer Figure 9c
3.	Loading ramp too wide allowing stock to baulk or turn around.	<ul style="list-style-type: none"> Stock will suffer stress and damage or jam across the ramp. Operator may enter the ramp or race in an attempt to move stock. 	<ul style="list-style-type: none"> Ramp width is determined by the stock being handled, generally the recommended internal width of a load/unload ramp is 800mm for cattle, 900mm for sheep and pigs. Dump ramps normally wider.
4.	Overall ramp height inappropriate.	<ul style="list-style-type: none"> Poor alignment with crate decks causing steps or gaps. Slip, trip, fall Injury to livestock or operator. 	<ul style="list-style-type: none"> For cattle and horses, ramp height should be 1100mm from the ground for single deck or bottom deck, and 2800mm for the top deck. For pigs, lambs, sheep, goats and calves suggested ramp heights are 1100mm from the ground for single deck or bottom deck, and 1400- 1600mm for top deck.
5.	Ramp wall heights inappropriate.	<ul style="list-style-type: none"> Too low will allow livestock to exit over the sides. Too high will prevent operators exiting in an emergency. 	<ul style="list-style-type: none"> Ramp wall height should be 1000mm for sheep and 1700mm for cattle. Note: Height should be at least 1200mm for goats or an additional top rail could be added.
6.	Ramp incline angle too steep creating difficulty in loading stock.	<ul style="list-style-type: none"> Stock will not move up a ramp that is too steep. Stock will slip and possibly lay down causing injury. 	<ul style="list-style-type: none"> Recommended ramp incline angle should not exceed 20 degrees. To assist loading and unloading cattle, there should be a flat platform not less than 1600mm in length at the top of the ramp that is level with the deck being unloaded.

10.3 Critical Control Point 3: Loading/unloading ramps, continued

#	HAZARD	RISKS	CONTROLS
7.	Ramp surface too smooth or covered in mud and effluent.	<ul style="list-style-type: none"> Stock will slip and possibly lay down causing injury. 	<ul style="list-style-type: none"> Ensure ramp surface is clean. Ideally, the ramp will be designed to drain or be self-cleaning. Flooring and surfaces should be designed to maximise grip and minimise slipping and falling. Strategies to improve grip include slats or grooves in the surface. Livestock prefer to walk up and down steps rather than inclines. For cattle, the surface should be made of non-slip material with either cross cleats, 40-50mm wide spaced at 300mm centres or, if concrete, a suitable cross-grooved pattern of steps to provide good footing when the ramp is wet. Recommended dimensions are 450mm treads and 100mm rises. Refer Figures 9a & 9b For sheep, ramp steps with 250mm of treads and 50mm rises or cross cleats 25mm wide and high at 200mm centres are recommended.
8.	Lack of infill on the sides of ramp and race walls.	<ul style="list-style-type: none"> No or limited infill on ramp side walls cause stock to baulk. There is also the potential for the legs of stock to slide out under the rails causing injury. Potential injury to people if arms or legs are placed through rail gaps or animal horns protrude. 	<ul style="list-style-type: none"> Installation of infill to the inside walls of ramps and races encourages stock to “run” plus reduces the risk of human injury. Refer Figure 9c On Under/Over ramps the bottom level walkway should be on the right hand side to aid line of sight into truck to monitor stock movement. Railings on ramps and raceways should be of appropriate height, with the gaps sufficiently narrow at the bottom to prevent livestock being caught, slipping through or becoming injured.



FIGURE 9a



FIGURE 9b

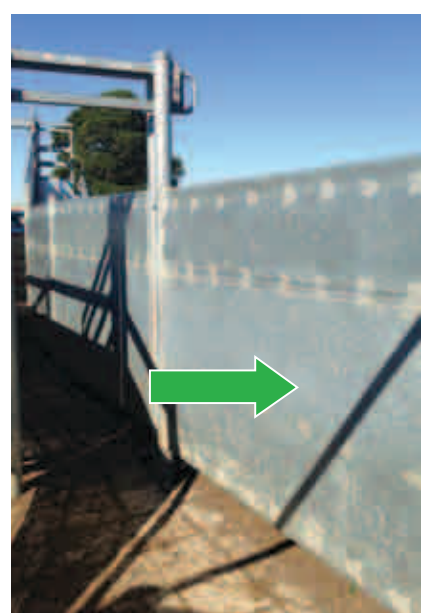

FIGURE 9c

10.3 Critical Control Point 3: Loading/unloading ramps, continued

#	HAZARD	RISKS	CONTROLS
9.	Adjustable ramps with faulty safety locks, no operating instructions or designed Safe Working Load displayed are dangerous.	<ul style="list-style-type: none"> • Incorrect use due to lack of instructions. • Unless ramp is locked into a set position it has the potential to fall causing damage to structures and injury to stock and operators. • Over loading or operating a ramp while loaded with stock poses a significant risk. • The structural load of the winch is different to its lifting capacity. This can lead to confusion if not clarified. 	<ul style="list-style-type: none"> • Where ramps are adjustable, appropriate safety locking devices must be installed (Refer Figures 10a & 10b) with clear instructions as to how they are to be used, including that the ramps must not be adjusted with people or stock on them. • Ramps should not be used if loading capacity is likely to be exceeded. Engineering design specifications and computations should be available from the supplier. • Mechanical safety locking devices should be automatic in operation and have vertical increments of no more than 100 mm. • Mechanical safety locks and lifting equipment should be regularly maintained and operational. Operating instructions and design rated capacity or working load limit must be clearly displayed. • Hoists / winches should be attached ensuring that the fixing point can handle the total load.



FIGURE 10a



FIGURE 10b

Note - If a vet crush is in line with a loading ramp these are the things to consider:

- gates in front of vet crush to be secure;
- consistent width from the vet crush through to the ramp to prevent the animal turning; and
- Vet crush operating handles should not impede continuous free access along the side of the vet crush to enable the operator to control stock.

10.4 Critical Control Point 4: Gaining access

#	HAZARD	RISKS	CONTROLS
1.	Climbing over rails and gates.	<ul style="list-style-type: none"> Potential slip, trip and fall injuries. 	<ul style="list-style-type: none"> Self-closing, inward-opening, 600mm wide, personal access or “man” gates with slam shut catches, strategically located provide safe access to working areas. For example (but not limited to) from the rear of the forcing yard to the walkway. Refer Figure 11
2.	Direct exposure to livestock.	<ul style="list-style-type: none"> Injury by being struck, kicked or crushed by animal. 	<ul style="list-style-type: none"> Install externally operated throw gates with slam shut catches. Refer Figures 16a & 16b Provision of a walkway for use by handlers on the outside of the ramp will reduce the need for the handler to enter yard or ramp. It can also facilitate easy stock movement and is essential on sheeted ramps. Access into the ramp and hence the vehicle from this walkway is also desirable to facilitate the closure of gates in the loading structure or vehicle. Walkways should be designed to be continuous without steps to avoid slip and trip hazards and without creating dead ends. Refer Figure 12 Walkways should ideally be positioned on both sides of ramps that can be elevated. If fitted on one side only, this should be on the left hand side (looking up from the base of the ramp) to facilitate closing of the crate door. Extendable walkways should be fitted where appropriate. The walkway should be constructed of a non-slip material, have adequate handrails and kick boards and comply with the Australian Standard – AS1657-2013, 'Fixed platforms, walkways, stairways and ladders - Design, construction and installation'.



FIGURE 11



FIGURE 12

10.4 Critical Control Point 4: Gaining access, continued

#	HAZARD	RISKS	CONTROLS
3.	Unauthorised access underneath ramp.	<ul style="list-style-type: none"> Injury potential in the event of collapse, falling objects or mechanical devices. 	<ul style="list-style-type: none"> Only authorised and appropriately trained persons should have access to the loading or unloading facility. Consider installing guarding around the base of ramps to prevent unauthorised access. Refer Figure 13



FIGURE 13

10.4 Critical Control Point 4: Gaining access, continued

#	HAZARD	RISKS	CONTROLS
4.	Loader climbing onto top or sides of the crate.	<ul style="list-style-type: none"> Higher risk of fall if ladder or platform is not provided to assist climbing onto the crate from the loading infrastructure. 	<ul style="list-style-type: none"> Subject to prevailing state regulations, a ladder or platform can be provided to help the loader to climb to the top of the crate to encourage animals to move through the crate from behind. This is particularly important on under & over ramps servicing trucks with walkways on the top of the crate (these trucks must have compliant walkways with safety rails or safety harnesses available to the operator). Refer Figures 14a - 14f



FIGURE 14a
Ladder enabling safe access from the ramp to the top of the crate



FIGURE 14b

Note - The edge of any walkway, platform, or landing where an object could fall more than 2 meters requires a 100mm toe-board to comply with the Australian Standard – AS1657-2013, 'Fixed platforms, walkways, stairways and ladders - Design, construction and installation'.



FIGURE 14c
Cross loading structure with walkway enabling safe access to the top of the crate and from one crate to another



FIGURE 14d



FIGURE 14e

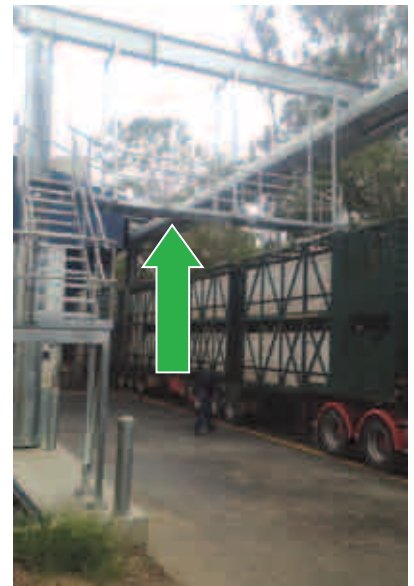

FIGURE 14f

10.5 Critical Control Point 5: Interface in forcing pen

#	HAZARD	RISKS	CONTROLS
1.	Slippery surfaces or protruding objects.	<ul style="list-style-type: none"> Slip, trip, fall or impact Injury to livestock or operator. 	<ul style="list-style-type: none"> Forcing pens should be constructed with non-slip flooring that is easy to clean and non-bruise material. Refer Figures 9a & 9b. Remove any sharp or protruding objects. Refer Figure 9c The gradient of the pen should provide adequate drainage e.g. 75mm per 1000mm.
2.	Direct exposure to livestock.	<ul style="list-style-type: none"> Injury by being struck or kicked by animal 	<ul style="list-style-type: none"> Forcing pens should be built to accommodate a pen of stock for the usual size stock vehicles using the facility, plus an additional 20% space (e.g. 1/2 a deck for semis which is usually 2.5m x 7m). Forcing pens designed so stock will run with no blind corners. Refer Figure 15 Forcing pens should be designed to enable the operator to move and direct stock from the walkway, without having to get in to the pen.



FIGURE 15

Note 1 – On smaller facilities externally operated slide gates can achieve an effective separation from livestock and can also be used in other places such as in a race instead of externally operated throw gates.

Note 2 - Multiple gates are advantageous to pen livestock and to prevent them from running backwards as they progress through the forcing yard and ramp.

Note 3 - Attempting to move stock for loading directly out of laneways to race/ramp area without holding pens should be avoided.

10.6 Critical Control Point 6: Gates striking operator

#	HAZARD	RISKS	CONTROLS
1.	Operator being struck by gate.	<ul style="list-style-type: none"> Crushing and striking injury due to throw back of gates. 	<ul style="list-style-type: none"> Throw gates externally operated with slam shut catches. Refer Figures 16a & 16b Consideration on which side the gate is hinged to minimise risk to the operator.
2.	Attempting to engage chains on gates under pressure.	<ul style="list-style-type: none"> Hand or finger laceration. 	<ul style="list-style-type: none"> Avoid using chain catches or slide bolt type catches on gates as the primary mechanism in high risk areas. <u>Note:</u> Chains or slide bolt on gates may be a suitable means of control in low use facilities. Chains should be secured to the post and attachable to the gate. Refer Figures 17a & 17b
3.	Non captive gate hinges cause gate lift off.	<ul style="list-style-type: none"> Damage to stock and operators. 	<ul style="list-style-type: none"> Ensure gate hinges are designed to prevent lift off.



FIGURE 16a
Externally operated gate at a commercial facility



FIGURE 16b
Externally operated gate at a farm



FIGURE 17a



FIGURE 17b

11.0 SUGGESTED RAMP DESIGNS

Livestock handling facilities can have different loading and unloading requirements depending upon the operation being conducted, intensity of use, type of stock being handled and the type of vehicles using the facility. There is no 'one size fits all' solution.

11.1 Single-deck and Multi-deck Ramps

The use of either single-deck or multi-deck ramps should take into consideration both the type of transport commonly used and the number of livestock being loaded/unloaded. Ramps that afford the direct delivery of livestock to the top deck of a vehicle such as adjustable single-deck ramps or multi-deck ramps should be considered to avoid livestock having to navigate the internal ramp of the vehicle. Multi-deck ramps decrease the duration of the stressful loading/unloading process.

In general, single-deck ramps are adequate for smaller farms and low intensity commercial facilities that use single deck transport, whilst adjustable single-deck ramps (preferred if only one ramp is provided) or multi-deck ramps should be used at saleyards, feedlots, abattoirs and larger farms.

11.2 Unloading Ramps

It is advantageous for some facilities to have specialist unloading ramps, commonly known as 'dump ramps'. Dump ramps are wider and offer animals an attractive 'clear run' out of the vehicle into a holding pen. However, it is dangerous to attempt to load animals from dump ramps and it is important that all facilities have at least one standard loading ramp to enable safe loading of animals that need to be transported away from the facility (e.g. because they were mistakenly unloaded). There are designs available that pair a narrow and a wide ramp side by side to allow maximum flexibility.

11.3 Total Number of Ramps

There are several elements that need to be taken into account when determining the number of ramps required for any given livestock handling facility. These include:

- **Peak capacity:** There needs to be an adequate number of ramps to efficiently handle the highest volume loading / unloading event that can be reasonably anticipated.
- **Capacity constraints:** Facility managers should seek to identify, reduce or remove any capacity constraints that otherwise impact on efficient animal flow. Examples of capacity constraints including weighing processes, restricted internal traffic flow or availability of vehicle parking.
- **Animal welfare:** Smooth and efficient loading improves animal welfare outcomes by decreasing the duration of stressful loading / unloading events.
- **Operator Safety:** Smooth and efficient loading lessens the likelihood of safety incidents occurring.
- **Driver Fatigue:** It is important to note that Heavy Vehicle National Law includes a 'chain of responsibility' that imposes general and specific liabilities on 'off-road' parties such as consignors, schedulers, loaders and executive officers to take reasonable steps to avoid engaging in practices that may contribute to driver fatigue (e.g. unreasonable queuing times). Managers should assess facility infrastructure and practices to identify and address any issues impacting on driver fatigue.

11.4 Designs for Cattle

Appendix A contains model designs for ramps and forcing yards for cattle that have been developed with close reference to the information outlined in this guide.

The model designs include:

- General overhead diagram of ramp and forcing yard layout;
- Basic single-deck ramp;
- Standard single-deck ramp;
- Side-loading single-deck ramp;
- Heavy-duty adjustable ramp;
- Under and over ramp; and
- Under and over dump ramp.

While care has been taken to develop widely applicable design options, facility operators should take into account their own specific risk profile to ensure that the design choice is the best solution for any particular facility. In some cases, it may be more appropriate to develop a new and unique design using the various individual elements of the model designs as well as innovative approaches to any unusual risks.

11.5 Designs for Sheep, Pigs, Lambs, Goats and Calves

Appendix B contains model designs for ramps and forcing yards for sheep, pigs, lambs, goats and calves that have been developed with close reference to the information outlined in this guide.

The model designs include:

- General overhead diagram of ramp and forcing yard layout;
- Mobile ramp;
- Basic single-deck ramp;
- Standard adjustable ramp; and
- Heavy-duty adjustable ramp.

While care has been taken to develop widely applicable design options, facility operators should take into account their own specific risk profile to ensure that the design choice is the best solution for any particular facility. In some cases, it may be more appropriate to develop a new and unique design using the various individual elements of the model designs as well as innovative approaches to any unusual risks.

11.6 Supporting Infrastructure

While this guide primarily deals with ramps and forcing yards, it is possible to apply innovative strategies to reduce risks for other elements of the loading task such as moving livestock through a trailer or transferring livestock from one trailer to another. Some examples include:

- a. Cross loading structure with walkway enabling safe access to the top of the crate and from one crate to another (Figure 14c);
- b. Railed gantry allowing access to the top of the crate from the side with illuminated walkway along the top of the trailer (Figure 14f); and
- c. Truck loading platform that can be brought alongside the trailer to provide safe access to assist moving animals through the crate at high volume destinations (see **Appendix C**).

Some features of the diagram at Appendix C include:

- Quick to engage and disengage;
- A 3 phase geared electric motor with triplex chain drive pivots the walkway frame alongside truck;
- Allows integration between loading ramp and unloading frame walkways;
- Allows safe operation of crate gates on all decks;
- Access to fold down bridging from A to B trailers;
- Walkways, stairways and handrails comply with Australian standards;
- Solid rubber wheels for stability and traction; and
- Galvanised construction.

Disclosure log

APPENDIX A - DESIGNS FOR CATTLE

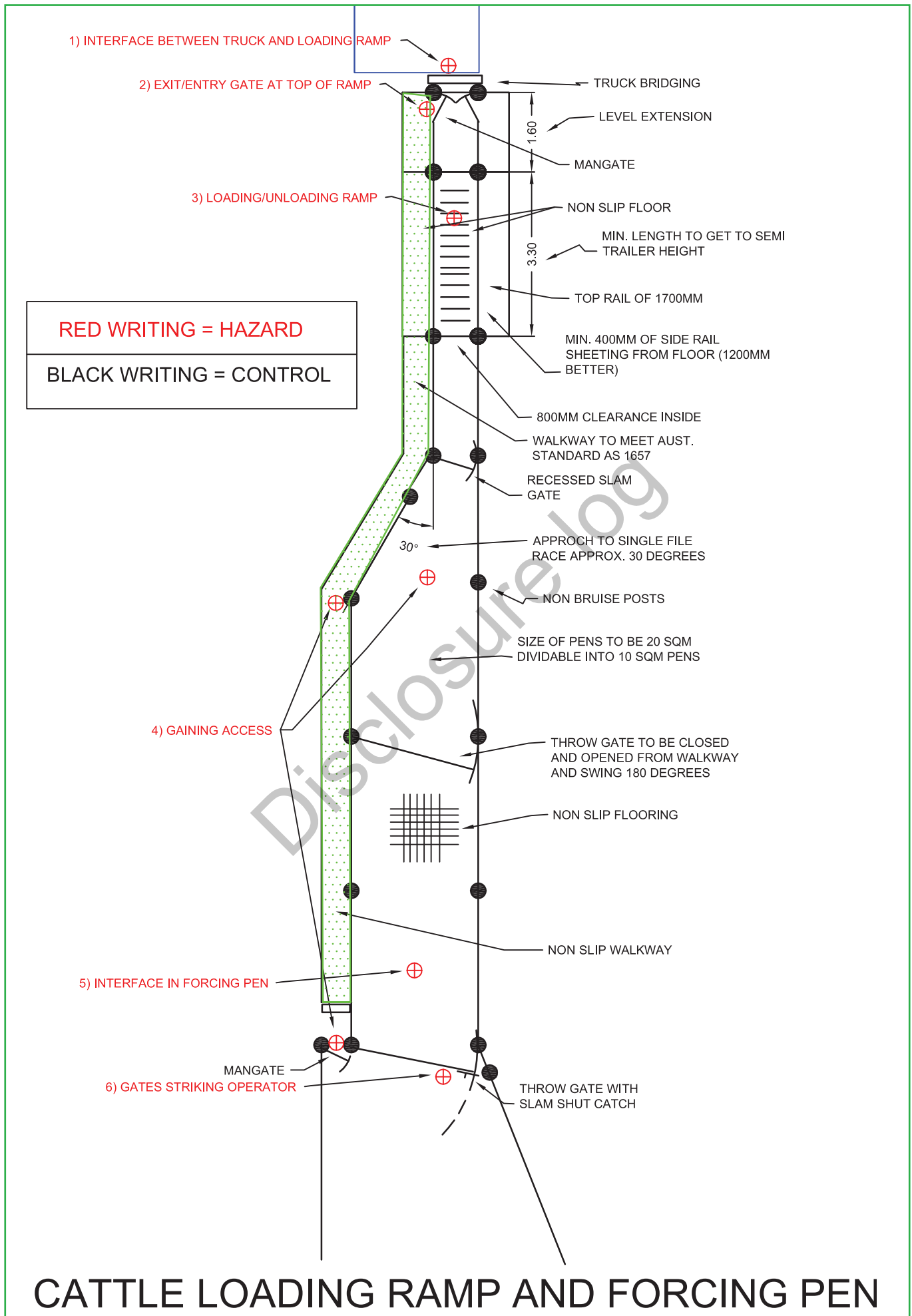

CATTLE LOADING RAMP AND FORCING PEN

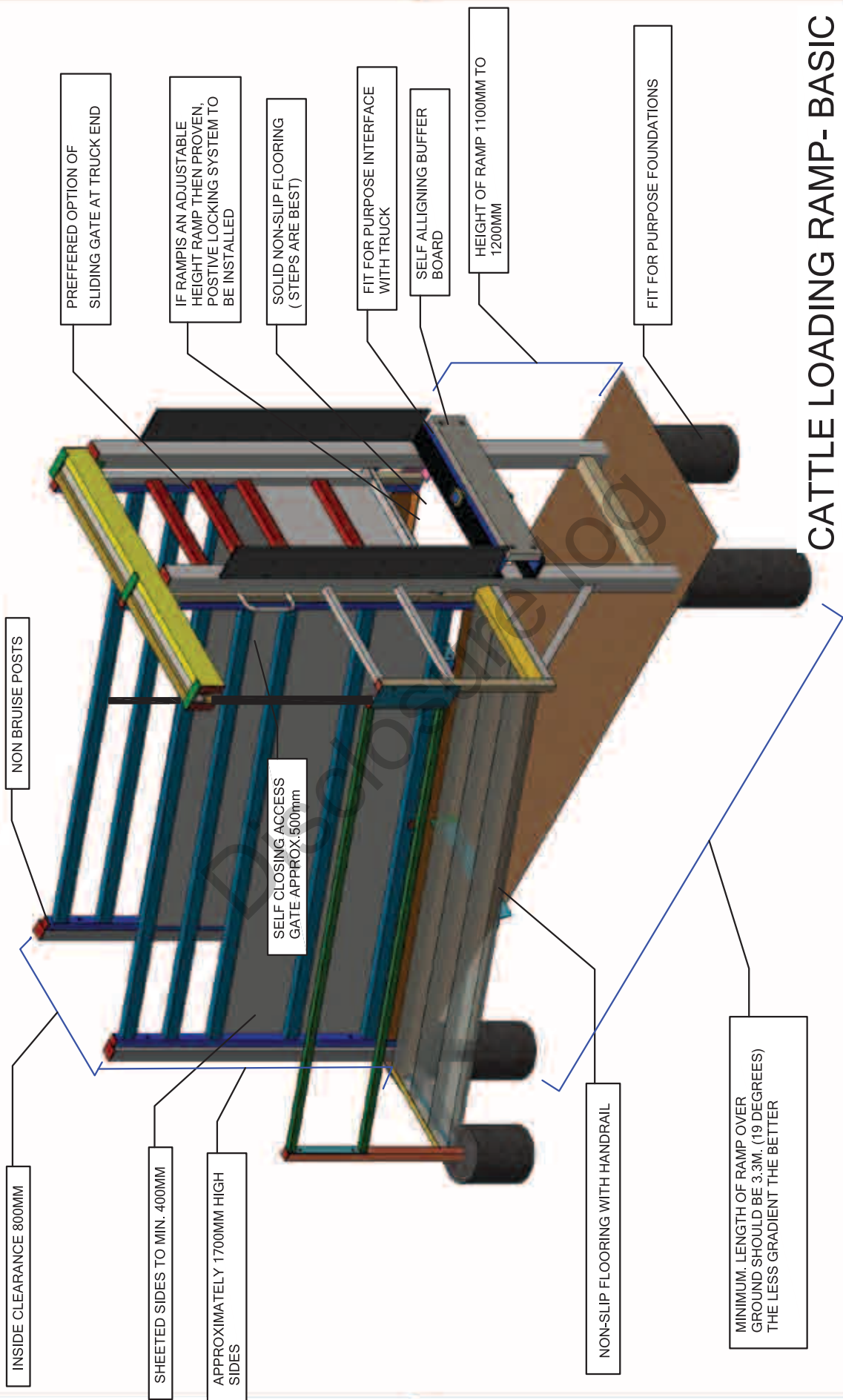

CATTLE LOADING RAMP- BASIC

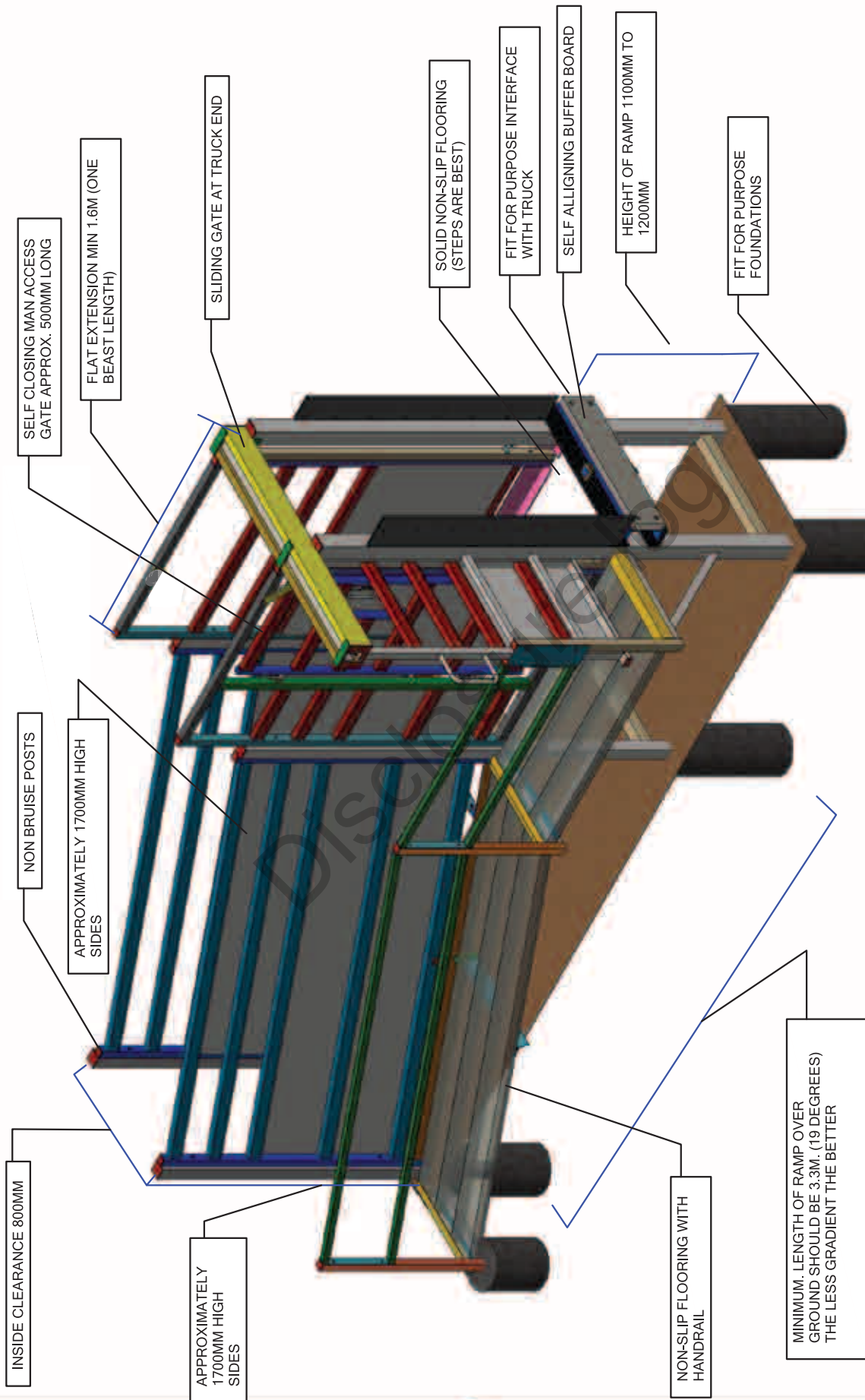

CATTLE LOADING RAMP-STANDARD

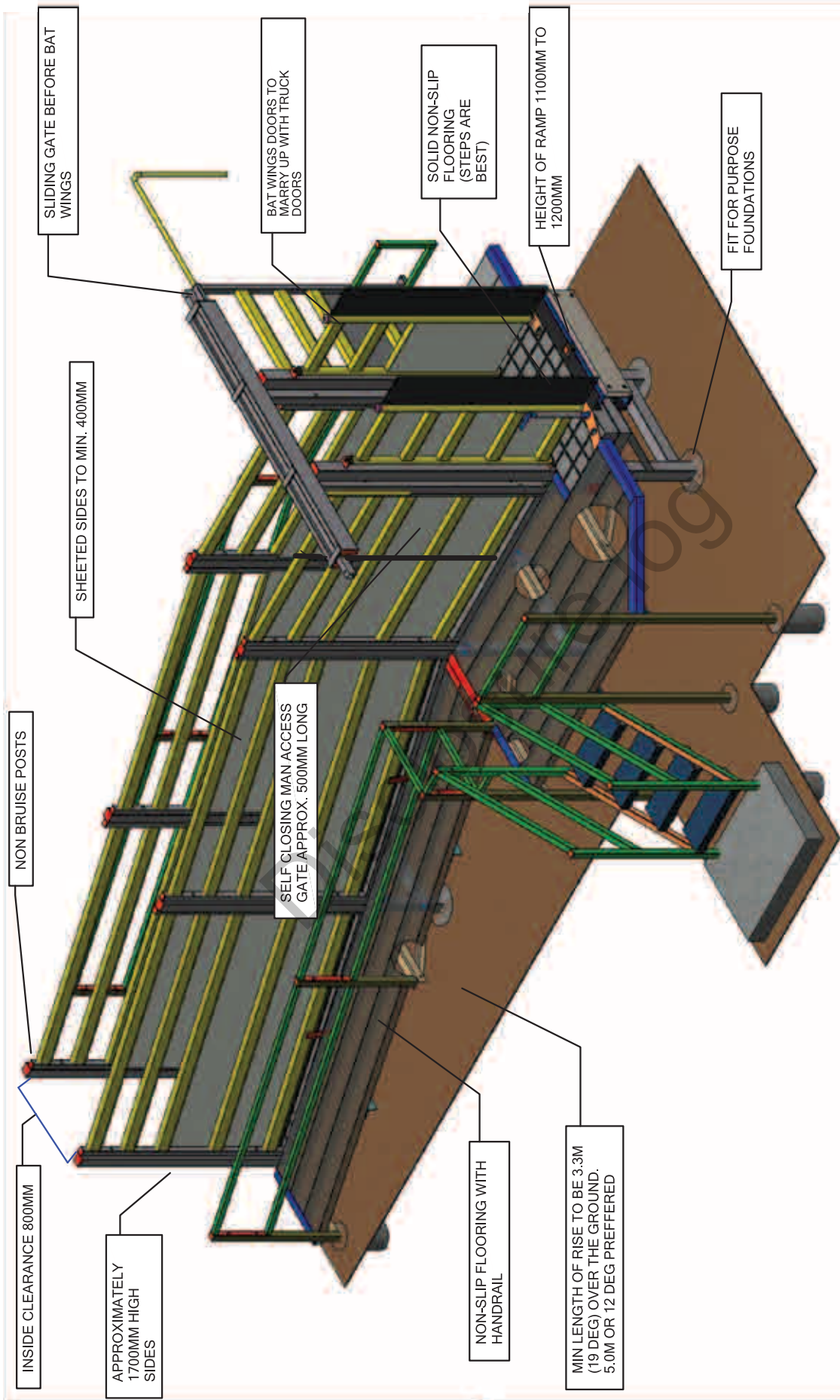

CATTLE LOADING RAMP- SIDE LOADING

DRAWING COURTESY OF **ProWay** Livestock Equipment 08/10/2014

NOTE: ON ADJUSTABLE LOADING RAMPS THERE MUST BE VISIBLE INSTRUCTIONS AS TO HOW TO OPERATE THE RAMP AND THE SAFE WORKING LOAD FOR THAT RAMP BE STATED

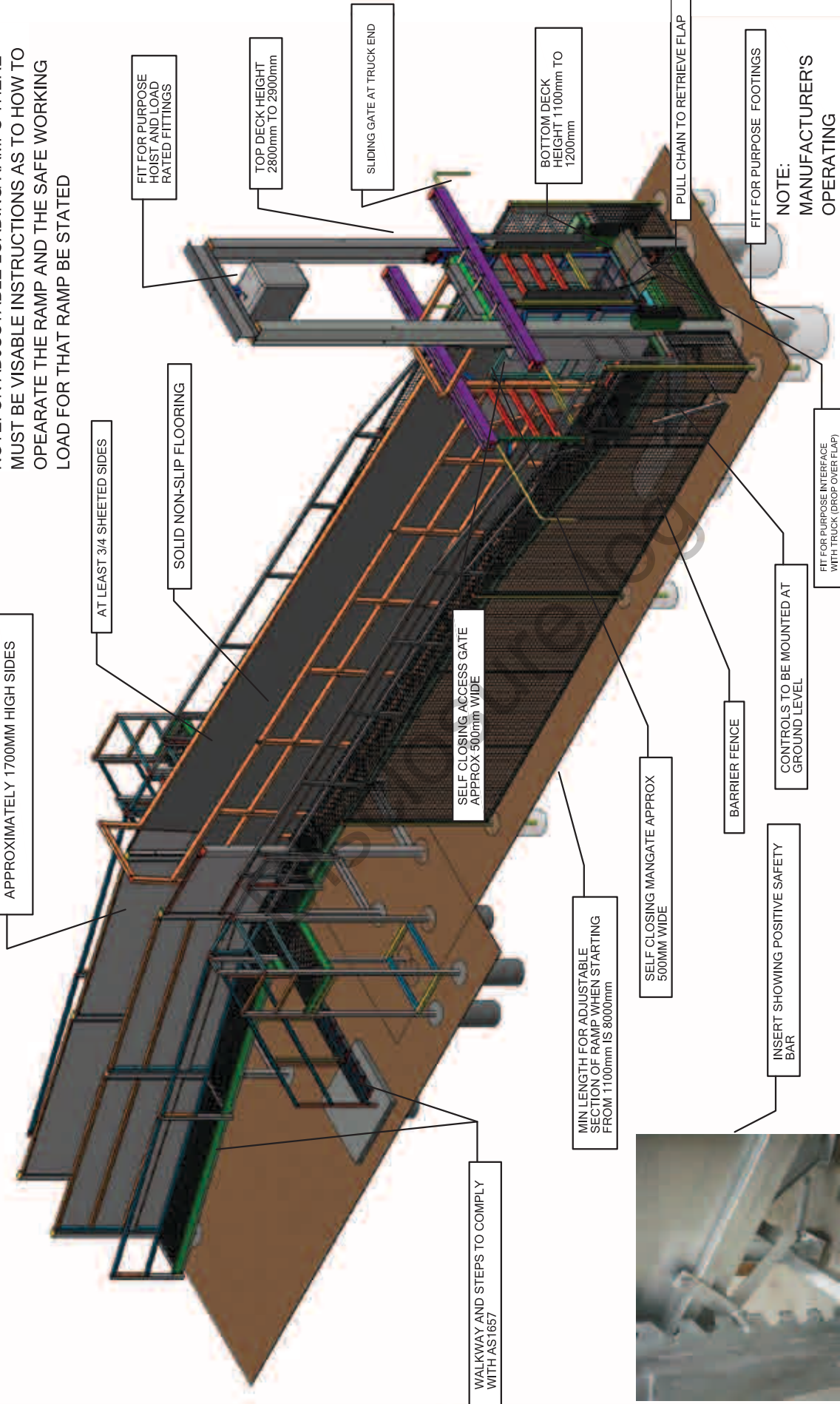

APPROXIMATELY 1700MM HIGH SIDES

AT LEAST 3/4 SHEETED SIDES

SOLID NON-SLIP FLOORING

FIT FOR PURPOSE HOIST AND LOAD RATED FITTINGS

TOP DECK HEIGHT 2800mm TO 2900mm

SLIDING GATE AT TRUCK END

BOTTOM DECK HEIGHT 1100mm TO 1200mm

PULL CHAIN TO RETRIEVE FLAP

FIT FOR PURPOSE FOOTINGS

NOTE: MANUFACTURER'S OPERATING INSTRUCTIONS TO BE DISPLAYED

FIT FOR PURPOSE INTERFACE WITH TRUCK (DROP OVER FLAP)

CONTROLS TO BE MOUNTED AT GROUND LEVEL

BARRIER FENCE

INSERT SHOWING POSITIVE SAFETY BAR

SELF CLOSING MANGATE APPROX 500MM WIDE

MIN LENGTH FOR ADJUSTABLE SECTION OF RAMP WHEN STARTING FROM 1100mm IS 8000mm

SELF CLOSING ACCESS GATE APPROX 500mm WIDE

WALKWAY AND STEPS TO COMPLY WITH AS1657



CATTLE LOADING RAMP- HEAVY DUTY ADJUSTABLE DECK

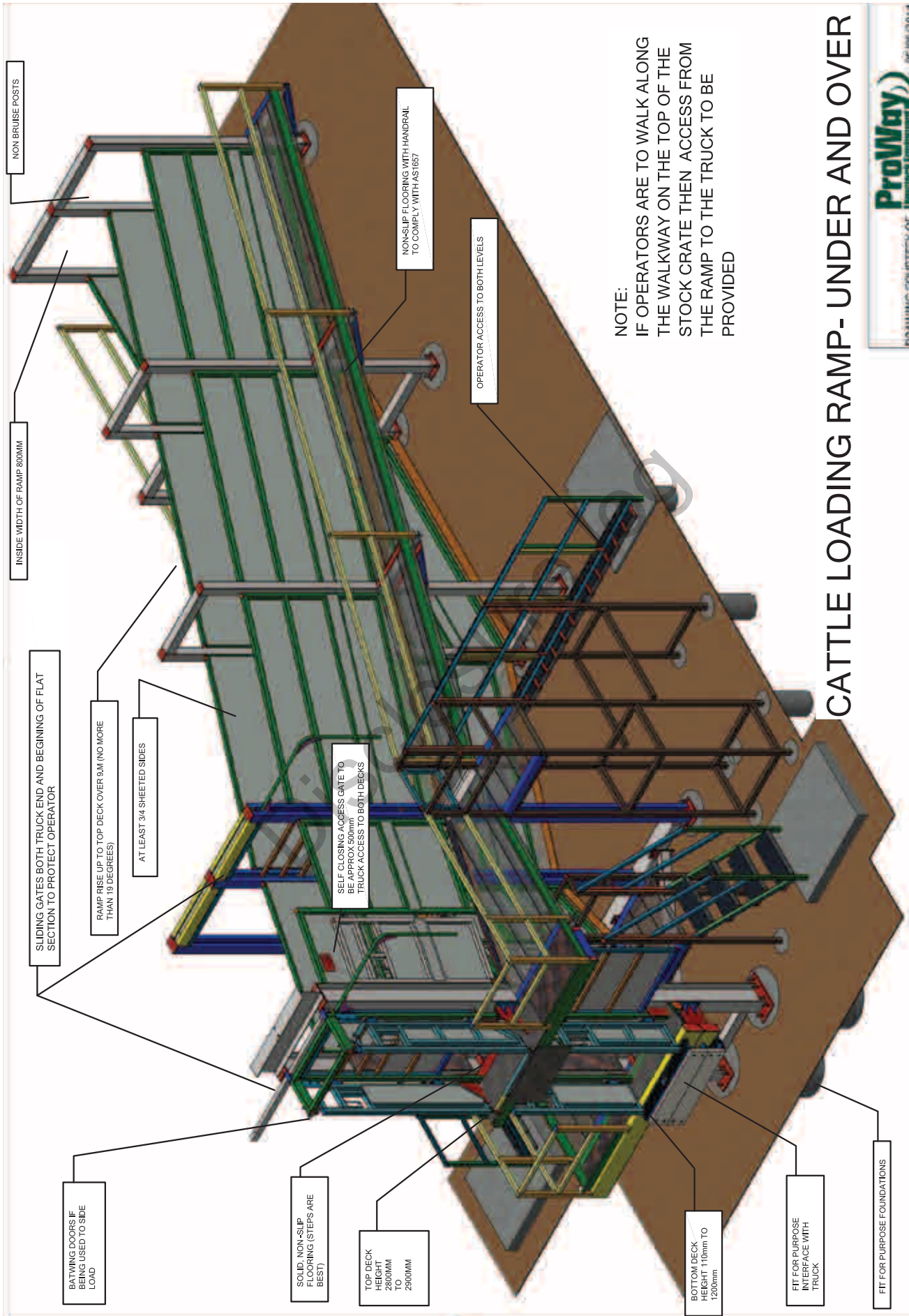

NOTE:
 IF OPERATORS ARE TO WALK ALONG THE WALKWAY ON THE TOP OF THE STOCK CRATE THEN ACCESS FROM THE RAMP TO THE TRUCK TO BE PROVIDED

CATTLE LOADING RAMP- UNDER AND OVER

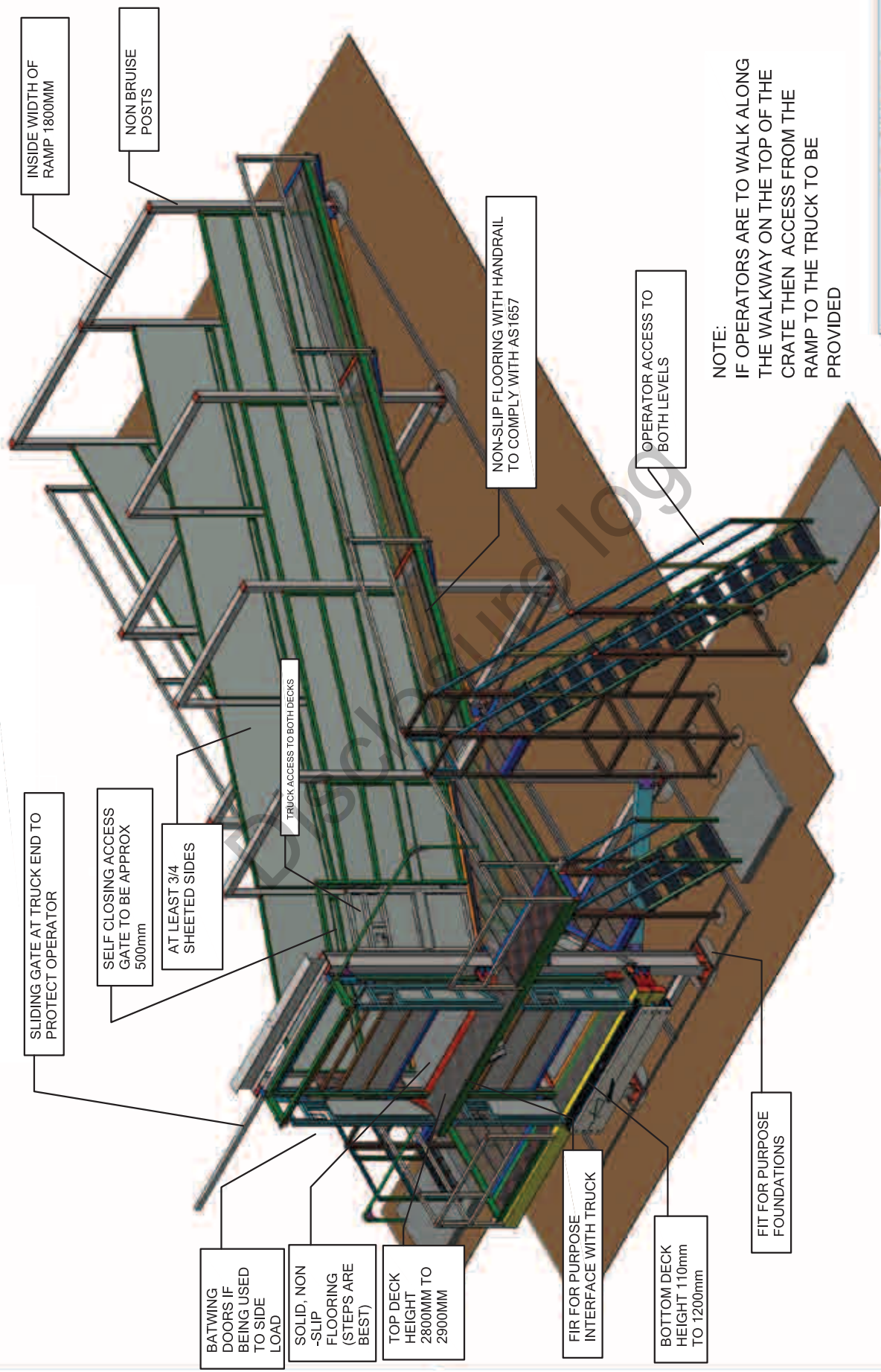

CATTLE UNLOADING DUMP- UNDER AND OVER

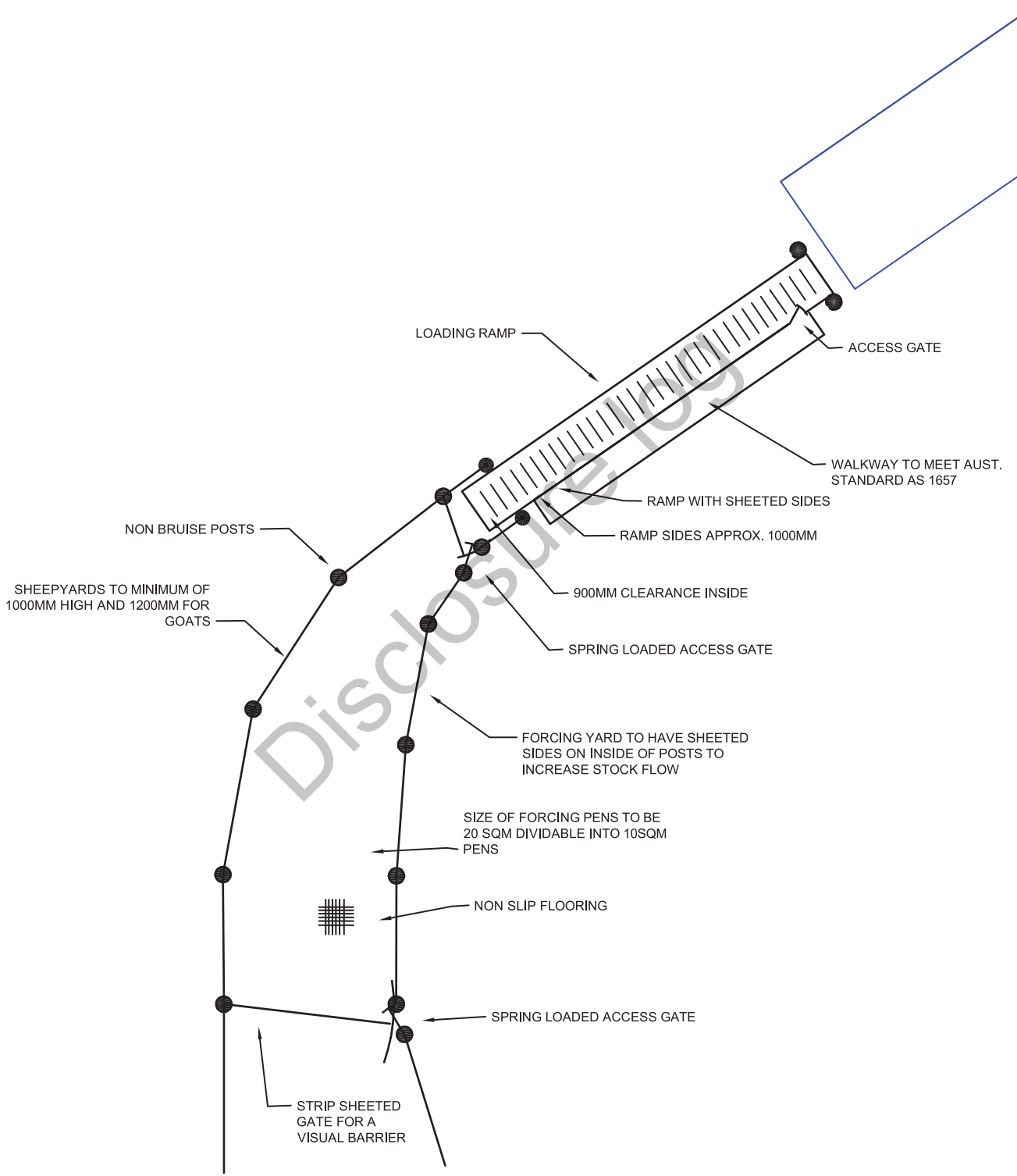

SHEEP LOADING RAMP AND FORCING PEN

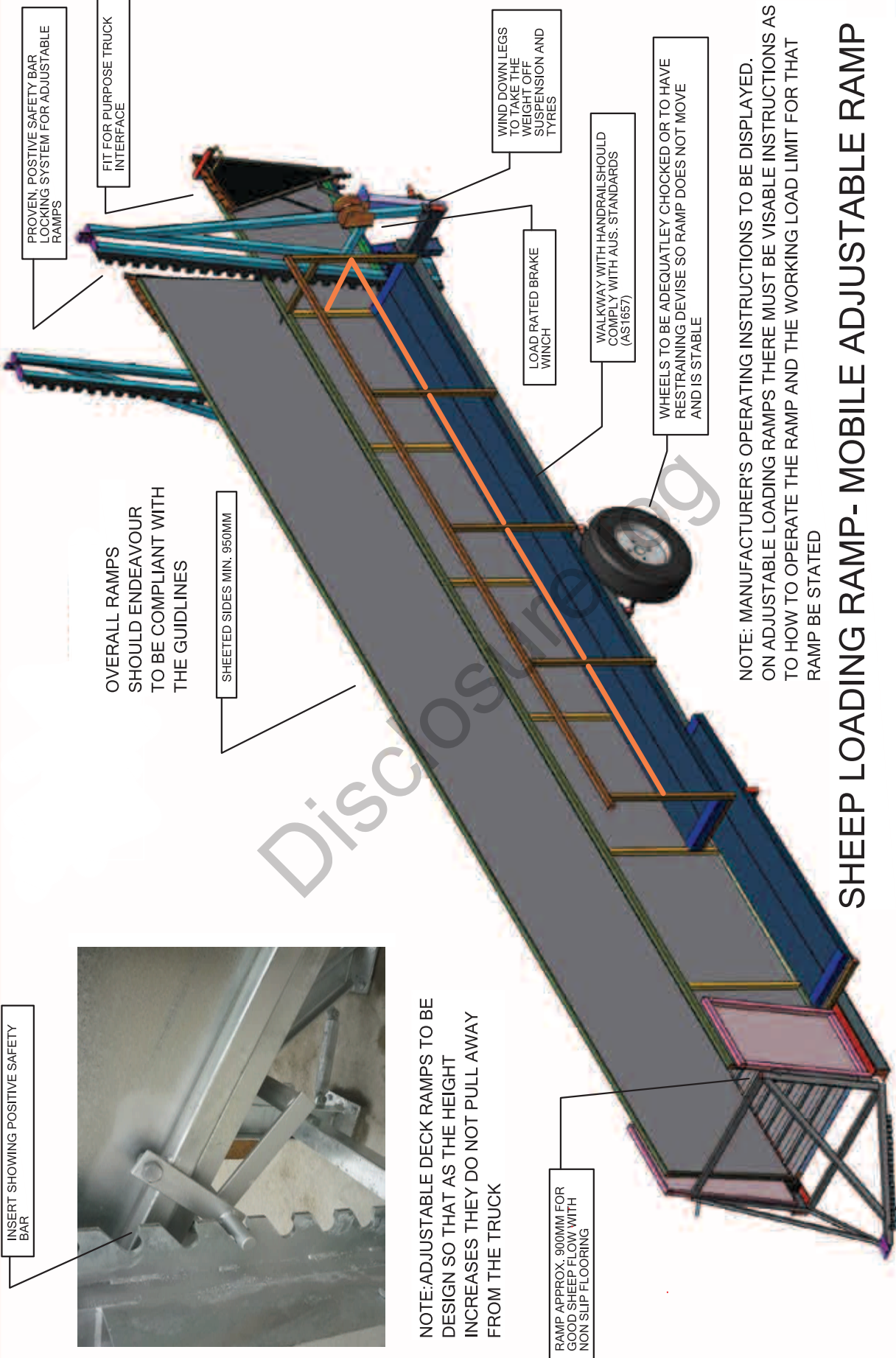

NOTE: MANUFACTURER'S OPERATING INSTRUCTIONS TO BE DISPLAYED. ON ADJUSTABLE LOADING RAMPS THERE MUST BE VISABLE INSTRUCTIONS AS TO HOW TO OPERATE THE RAMP AND THE WORKING LOAD LIMIT FOR THAT RAMP BE STATED

SHEEP LOADING RAMP- MOBILE ADJUSTABLE RAMP



SECURE HITCHING FRAME FOR TOWING (MAX TOWING SPEED FOR AG MACHINERY IS 40kph)

NOTE: DESIGN RAMP SIDES FOR THE TYPE OF STOCK TO BE HANDLED I.E GOAT RAMPS UP TO 1200MM HIGH SIDES

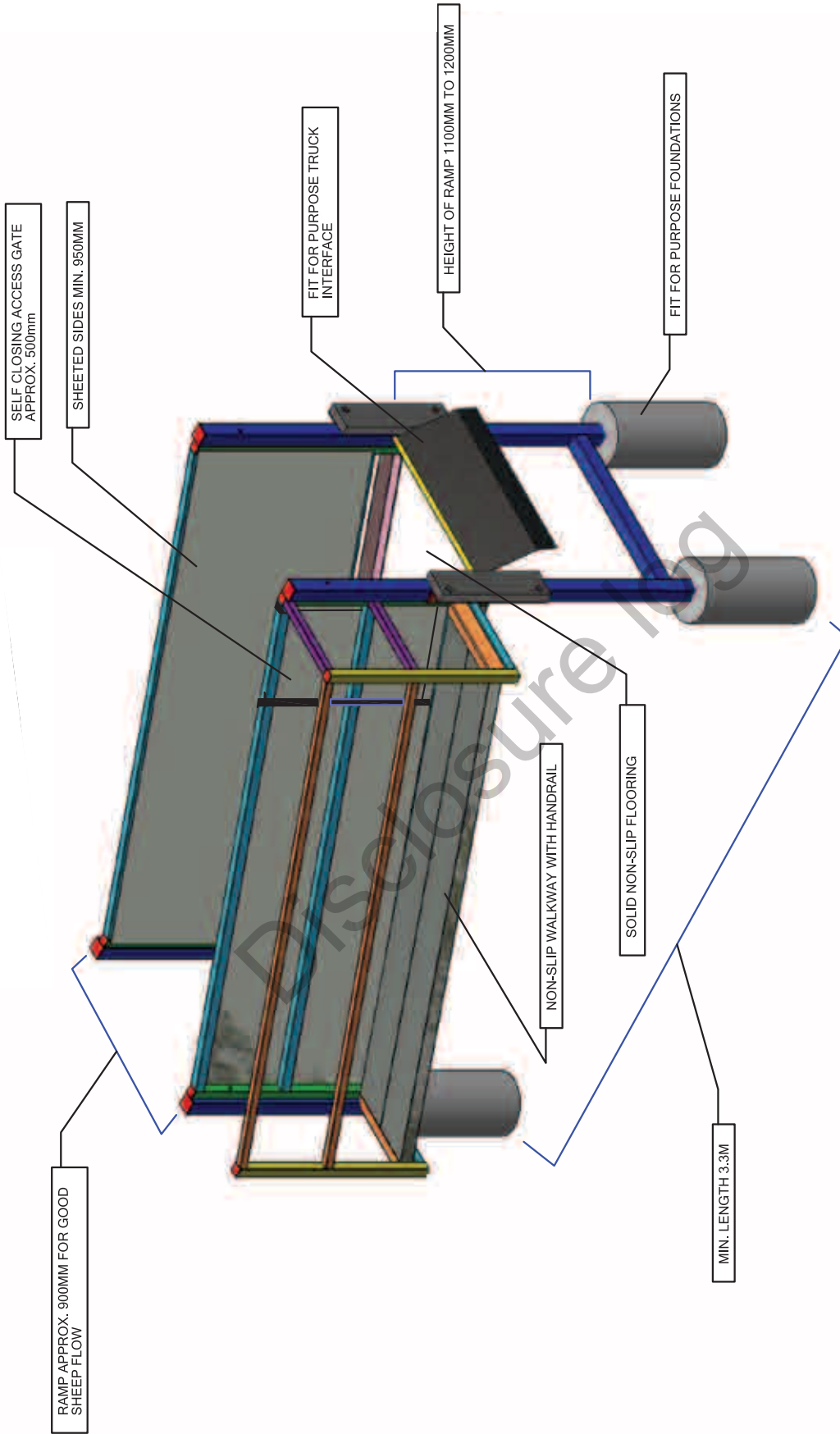

SHEEP LOADING RAMP-BASIC



NOTE: ON ADJUSTABLE LOADING RAMPS THERE MUST BE VISIBLE INSTRUCTIONS AS TO HOW TO OPERATE THE RAMP AND THE SAFE WORKING LOAD FOR THAT RAMP BE STATED

RAMP APPROX. 900MM FOR GOOD SHEEP FLOW

SHEETED SIDES MIN. 950MM

FOR RAMP TO REACH 3RD DECK OF TRUCK (2850MM) THEN RAMP TO BE 8M LONG FROM GROUND LEVEL

SELF CLOSING ACCESS GATE APPROX. 500mm

WALKWAY TO COMPLY WITH AS1657

NON-SLIP WALKWAY WITH HANDRAIL

INSERT SHOWING POSITIVE SAFETY BAR

SAFETY BAR RELEASE MECHANISM TO BE OPERATED FROM GROUND

LOAD RATED BRAKE WINCH

FIT FOR PURPOSE FOUNDATIONS

NOTE: MANUFACTURER'S OPERATING INSTRUCTIONS TO BE DISPLAYED

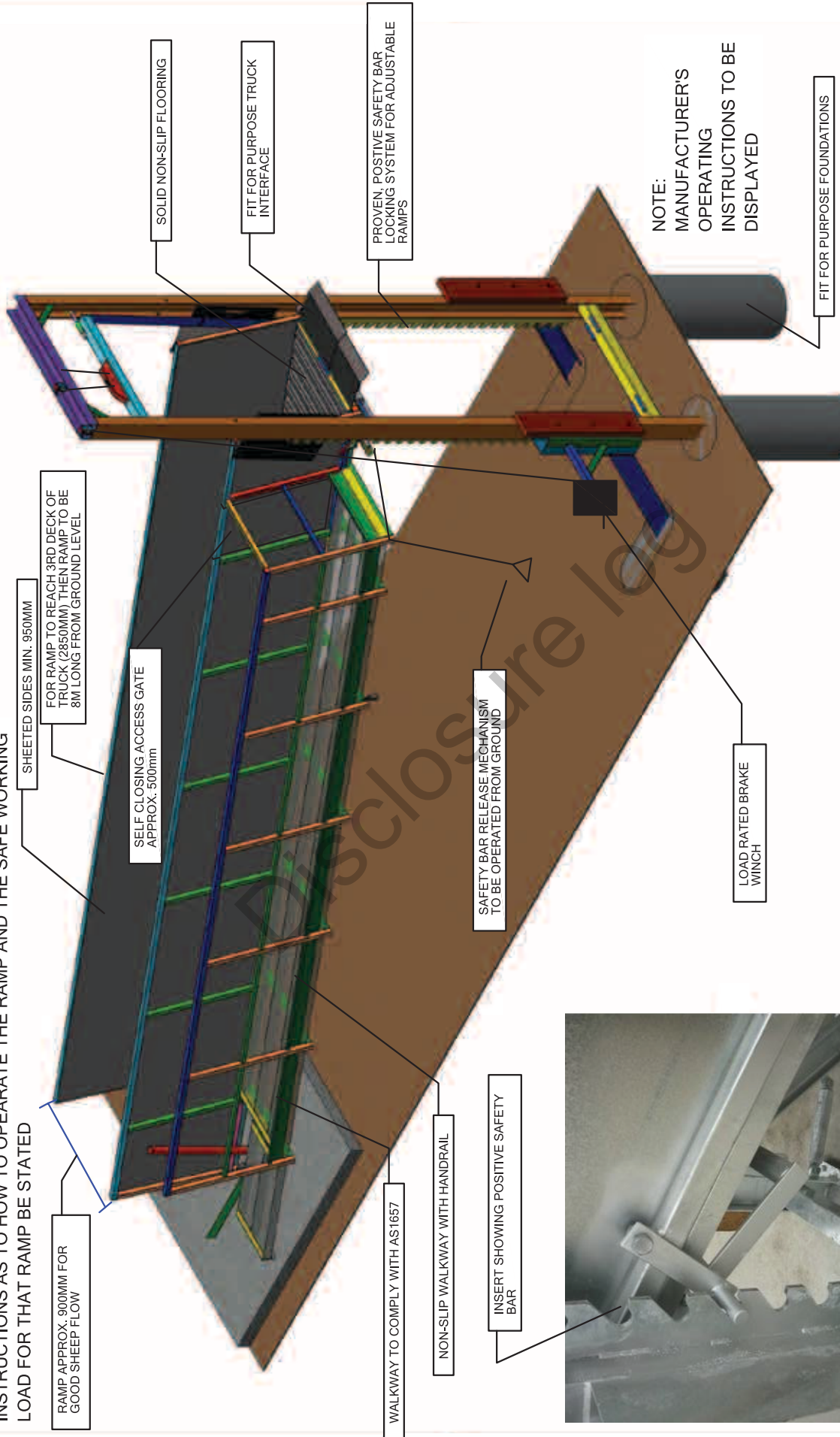

SHEEP LOADING RAMP-ADJUSTABLE TO 3RD DECK

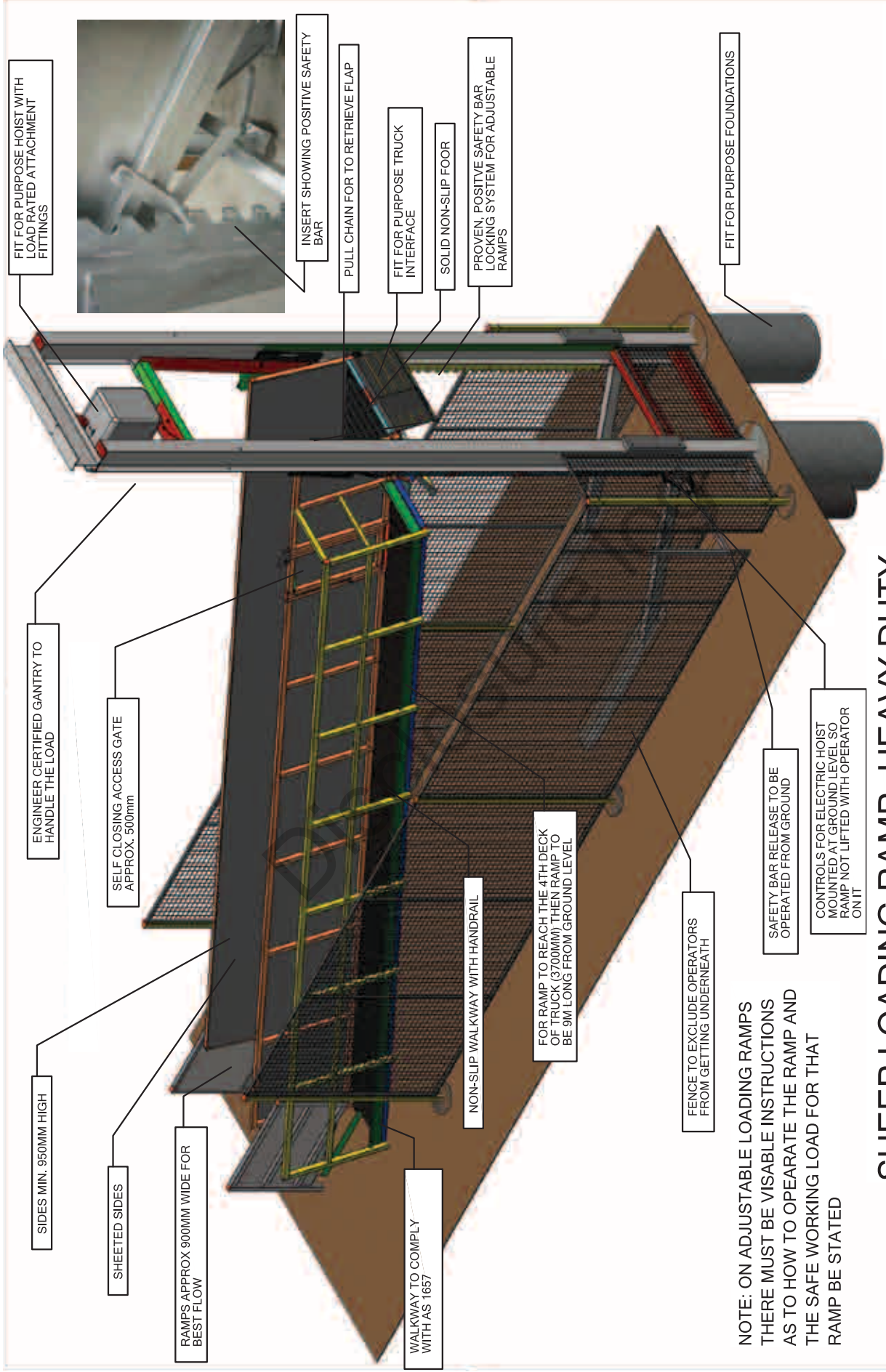

FIT FOR PURPOSE HOIST WITH LOAD RATED ATTACHMENT FITTINGS



INSERT SHOWING POSITIVE SAFETY BAR

PULL CHAIN FOR TO RETRIEVE FLAP

FIT FOR PURPOSE TRUCK INTERFACE

SOLID NON-SLIP FLOOR

PROVEN, POSITIVE SAFETY BAR LOCKING SYSTEM FOR ADJUSTABLE RAMPS

FIT FOR PURPOSE FOUNDATIONS

ENGINEER CERTIFIED GANTRY TO HANDLE THE LOAD

SELF CLOSING ACCESS GATE APPROX. 500mm

SIDES MIN. 950MM HIGH

SHEETED SIDES

RAMPS APPROX 900MM WIDE FOR BEST FLOW

WALKWAY TO COMPLY WITH AS 1657

NON-SLIP WALKWAY WITH HANDRAIL

FOR RAMP TO REACH THE 4TH DECK OF TRUCK (3700MM) THEN RAMP TO BE 9M LONG FROM GROUND LEVEL

FENCE TO EXCLUDE OPERATORS FROM GETTING UNDERNEATH

SAFETY BAR RELEASE TO BE OPERATED FROM GROUND

CONTROLS FOR ELECTRIC HOIST MOUNTED AT GROUND LEVEL SO RAMP NOT LIFTED WITH OPERATOR ON IT

NOTE: ON ADJUSTABLE LOADING RAMPS THERE MUST BE VISIBLE INSTRUCTIONS AS TO HOW TO OPERATE THE RAMP AND THE SAFE WORKING LOAD FOR THAT RAMP BE STATED

SHEEP LOADING RAMP- HEAVY DUTY



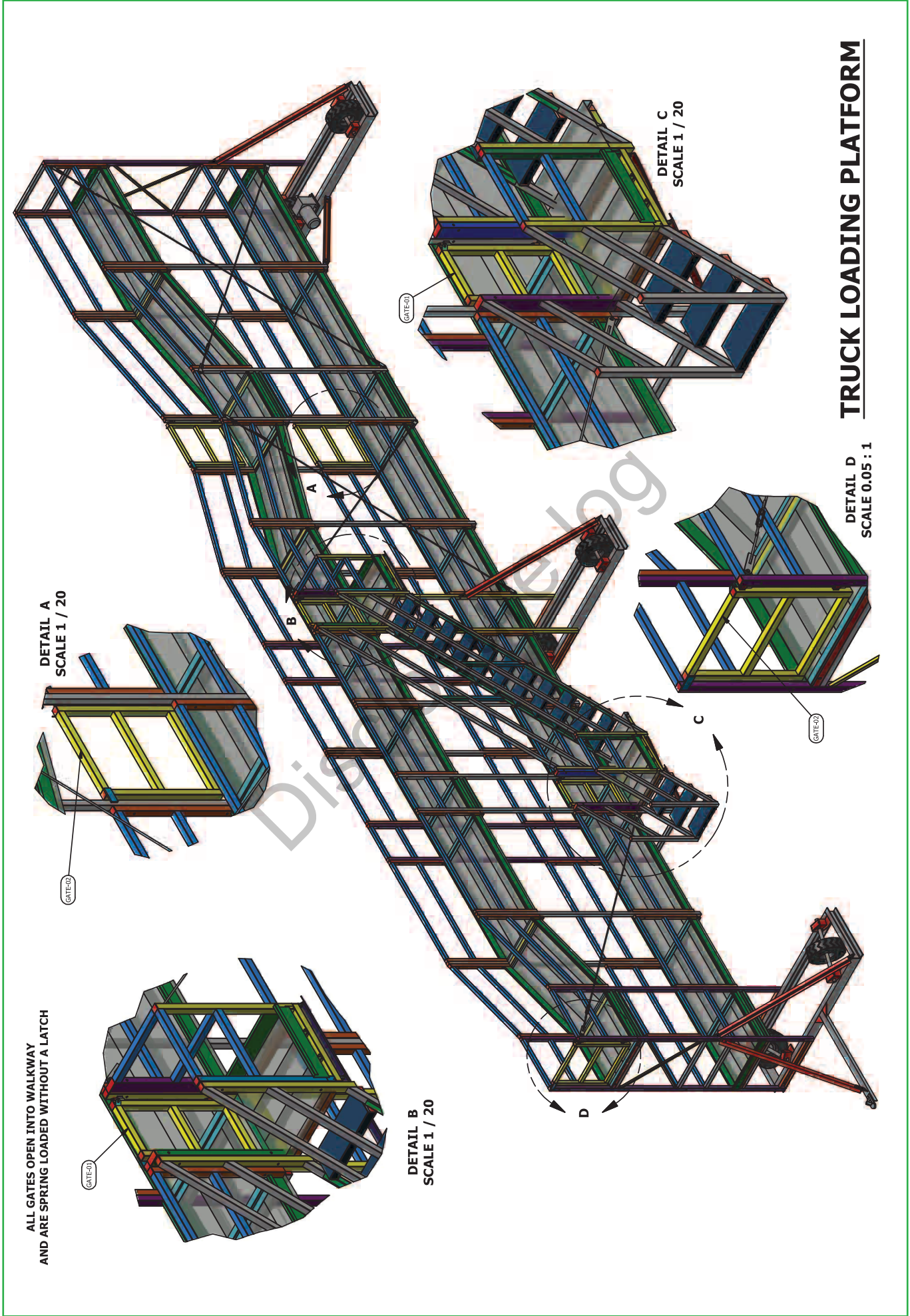

APPENDIX D - GLOSSARY OF TERMS

Control – a control measure, in relation to a risk to health and safety, means a measure to eliminate or minimise the risk to people or animals. Involves a hierarchy of controls including: elimination; substitution; isolation; engineering; administration; personal protective equipment.

Critical Control Point – a point at which failure to control risk may cause harm to people or animals.

Dump Ramp – A wider ramp designed for high volume unloading.

Duty – a duty imposed on a person to minimise risks to health and safety to people and animals so far as is reasonably practicable. Duties cannot be transferred. A person may have more than one duty and more than one person can have the same duty.

Emergency Exit Gate – a gate at the top of a ramp used to rapidly exit a ramp onto a platform when there is a risk of being struck by an animal.

Fold Over Flaps – Adjustable curved flaps attached to the top of a ramp designed to eliminate any gap between the truck and ramp. Must be fitted with a chain to assist in retrieval.

Forcing Yard – a holding pen which allows operators to encourage animals up the race or ramp while maintaining segregation between stock and people. There are different shapes including conventional or round style designs.

Hazard – means a situation or thing that has the potential to cause harm. This can apply to possible mechanical damage to equipment as well as injury to people and livestock.

Personal Access Gate – A gate conveniently positioned to allow an operator to safely enter or exit the internal structure of livestock facility.

Race - normally a set of parallel panels leading up to the ramp.

Ramp – the stockyard structure used for loading and unloading livestock.

Risk – is the possibility that harm (death, injury or illness) might occur to a person or animal when exposed to a hazard.

Safety Locking Device - failsafe system to hold the ramp in a set position while it is being used.

Slam Shut Catch – part of a latch that is designed to automatically engage when a gate is thrown or pushed shut.

Slide Gate – Usually located at the top of the ramp used to prevent animals from re-entering the ramp once loaded into a vehicle and allowing for easy flap retrieval. Sliding gates can also be used in other places such as in a race instead of throw gates.

Throw gate – An internal gate that includes a slam shut catch that can be operated from an external position.

Walkway – A designated walking surface used for moving from one point to another. See *Australian Standard 1657-2013 Fixed Platforms, walkways, stairways and ladders – Design, construction and installation*.

Winch – a mechanical lifting device used to change height or incline of a loading ramp.

APPENDIX E - KEY CONTACTS

The following organisations have been involved in the development of this publication:

ORGANISATION	CONTACT DETAILS
Australian Livestock and Rural Transporters Association	Phone: 02 6247 5434 Email: office@alrta.org.au Web: www.alrta.org.au
Livestock and Rural Transporters Association of Victoria	Phone: 0400 933 713 Email: office@lrtav.com.au Web: www.lrtav.com.au
Livestock and Bulk Carriers Association	Phone: 02 6230 6290 Email: office@lbca.org.au Web: www.lbca.org.au
Livestock and Rural Transporters Association of Queensland	Phone: 07 4778 4048 Email: ltaq@bigpond.com Web: www.lrtaq.com.au
Livestock and Rural Transporters Association of Western Australia	Phone: 08 9208 0320 Email: bennetta@lrtawa.org.au Web: www.lrtawa.org.au
Livestock and Rural Transporters Association of South Australia	Phone: 0400 653 613 Email: admin@lrtasa.com.au Web: www.lrtasa.com.au
Livestock Transporters Association of Tasmania	Phone: 0409 126 788 Email: spencer.griggs01@bigpond.com
Australian Livestock and Marketing Association	Phone: 02 6373 1435 Email: executive@saleyards.info Web: www.saleyards.info
Livestock Saleyards Association of Victoria	Phone: 03 5286 8219 Email: lsav@bigpond.net.au Web: www.lsav.com.au
Victorian Farmers Federation	Phone: 1300 882 833 Email: members@vff.org.au Web: www.vff.org.au
NSW Farmers Association	Phone: 02 9478 1000 Email: emailus@nswfarmers.org.au Web: www.nswfarmers.org.au
NSW Workcover	Phone: 13 10 50 Email: contact@workcover.nsw.gov.au Web: www.workcover.nsw.gov.au
Cattle Council of Australia	Phone: 02 6269 5600 Email: cca@cattlecouncil.com.au Web: www.cattlecouncil.com.au
Safe Work Australia	Phone: 1300 551 832 Email: info@swa.gov.au Web: www.safeworkaustralia.gov.au

WorkSafe Victoria	Phone: 03 9641 1444 Email: info@worksafe.vic.gov.au Web: www.worksafe.vic.gov.au
ProWay Livestock Equipment	Phone: 1300 655 383 Email: information@proway.com.au Web: www.proway.com.au
Australian Pork Limited	Phone: 02 6285 2200 Email: apl@australianpork.com.au Web: www.australianpork.com.au
Meat and Livestock Australia	Phone: 02 9463 9333 Email: info@mla.com.au Web: www.mla.com.au
Australian Department of Infrastructure and Regional Development	Phone: 1800 075 001 Email: media@infrastructure.gov.au Web: www.infrastructure.gov.au
Animals Angels Australia	Phone: 0424 288 771 Email: animalsangels@iinet.net.au Web: www.animals-angels.com
RSPCA	Web: www.rspca.org.au
South East Australian Livestock Exporters Association	Phone: 08 8527 2153 Email: ems_liveexp@smartchat.net.au
Australian Livestock Export Council	Phone: 02 9929 6755 Email: livecorp@livecorp.com.au Web: www.livecorp.com.au
Kattle Gear Australia	Phone: 03 5442 3477 Email: kattlegear@bigpond.com Web: www.kattlegear.com.au
Thompson Longhorn	Phone: 07 4666 6174 Email: sales@thompsonlonghorn.com.au Web: www.thompsonlonghorn.com.au
National Saleyards Quality Assurance Program standards	Phone: 0418 837 598 Email: nsqa@bigpond.net.au Web: www.nsqa.com.au

APPENDIX F - SAFETY AUTHORITIES

ORGANISATION	CONTACT DETAILS
Safe Work Australia	Phone: 1300 551 832 Email: info@swa.gov.au Web: www.safeworkaustralia.gov.au
WorkSafe Victoria	Phone: 03 9641 1444 Email: info@worksafe.vic.gov.au Web: www.worksafe.vic.gov.au
NSW Workcover	Phone: 13 10 50 Email: contact@workcover.nsw.gov.au Web: www.workcover.nsw.gov.au
Worksafe ACT	Phone: 02 6207 3000 Email: worksafe@act.gov.au Web: www.worksafe.act.gov.au
NT Worksafe	Phone: 1800 019 115 Email: ntworksafe@nt.gov.au Web: www.worksafe.nt.gov.au
Workplace Health and Safety Queensland	Phone: 1300 362 128 Web: www.worksafe.qld.gov.au
SafeWork SA	Phone: 1300 365 255 Email: help@safework.sa.gov.au Web: www.safework.sa.gov.au
WorkSafe Tasmania	Phone: 03 6166 4600 Email: wstinfo@justice.tas.gov.au Web: www.worksafe.tas.gov.au
WorkSafe WA	Phone: 08 9327 8777 Email: safety@commerce.wa.gov.au Web: www.commerce.wa.gov.au/WorkSafe/

APPENDIX G - REFERENCE MATERIAL

The guide does not replace any statutory or accreditation requirements that may apply. It should be read in conjunction with:

- Various State/Territory work health and safety laws;
- Various State/Territory prevention of cruelty to animals laws;
- Heavy Vehicle National Law;
- Building Code of Australia;
- Australian Standard AS 1657 2013: *Fixed platforms, walkways, stairways and ladders – design, construction and installation*;
- Australian Standard AS 1418.2 1997: *Cranes (including hoists and winches) Part 2 Serial hoists and winches*;
- Australian Standards for working at heights (various);
- Safe Work Australia guidance for the safe design, manufacture, import and supply of plant;
- Guidance information to identify hazards and risks associated with the interface of people and livestock – Livestock and Rural Transporters Association of Victoria;
- Australian Animal Welfare Standards and Guidelines for Livestock and Saleyards and Depots (proposed);
- Australian Animal Welfare Standards for Land Transport of Livestock;
- TruckCare;
- ALMA Code of Practice for Livestock Saleyards and Lairages;
- National Saleyards Quality Assurance Program standards;
- Guidance on the Safe Handling of Livestock and Marts and Lairages (Ireland);
- Recommended Basic Livestock Handling – Dr Temple Grandin; and
- Recommended Animal Handling Guidelines and Audit Guide for Cattle, Pigs, and Sheep – American Meat Institute Foundation.

Disclosure log

APPENDIX H - ACKNOWLEDGEMENTS

This guide was developed by the Australian Livestock and Rural Transporters Association in cooperation with stakeholders within the livestock supply chain, community and State, Territory and Federal Governments.

The extraordinary contributions of the following people and organisations are specifically acknowledged:

- John Beer
- Kevin Simmonds
- Livestock and Rural Transporters Association of Victoria
- Australian Livestock and Rural Transporters Association
- ProWay Livestock Equipment
- WorkSafe Victoria
- Safe Work Australia
- Livestock Saleyards Association of Victoria
- Cattle Council of Australia
- Victorian Farmers Federation
- Beaurepaire

Disclosure log

NOTES

Disclosure log

Disclosure log

Disclosure log

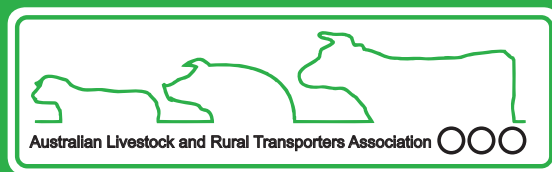

Australian Livestock and Rural Transporters Association

Phone: 02 6247 5434

Email: office@alrta.org.au

Web: www.alrta.org.au